

User Manual of High Bay

Version: 01

Product Introduction:

Welcome to purchase our led high bay light, which is with imported high-brightness SMD2835 led chip, with unique high purity die-cast aluminum heat sink, and high efficiency constant current or constant voltage driver. Ideal product for the factories, Stadiums, gas stations, train stations, and similar applications

Product Features:

1. The material of heat sink is high thermal conductivity die-cast aluminum, good for heat dissipation and the surface is anti-static.
2. Multiple power, beam angle, installation methods, and accessories are available for selection.
3. This fixture is waterproof, dustproof, anticorrosive.

Warning:

1. please read the manual carefully before installation
2.  caution, electric shock risk
3. The luminaire must be installed by qualified electrician in accordance with local rules and codes.
4. The external flexible cable or cord of this luminaire cannot be replaced; if the cord is damaged, the luminaire shall be destroyed
5. please keep the fixture out of fire, electric shock, vibration
6. The regular sensor could not be used with Emergency Driver at the same time. If the sensor should be worked with Emergency Driver at the same time, please ask for a special type.

Technical Parameters:

Product/Parameter	100W/150W	200W	240W	300W	400W	500W	600W
Input Voltage	AC100-277V; EU-Standard (Lifud): AC220-240V			AC100-277V			
Power Frequency	50/60Hz						
Material	ADC12 aluminum						
Driver	lifud/sosen			sosen			
Working Temperature	-30 C ~ 50 C						
Storing Temperature	-40 C ~ 65 C						
Working Humidity	15% ~ 95% RH						
Beam Angle	60°/90°/120°			120°			
Color Temperature	4000K/5000K/5700K/6500K						
Net Weight	2.2kg±0.3	2.4kg±0.3	3.1kg±0.3	5.5kg±0.5	6.2kg±0.5	9.45kg±0.8	14.6kg±0.8
Lamp Dimension	φ260*125mm	φ260*145mm	φ260*146mm	φ320*150mm	φ320*182mm	φ375*196mm	φ375*224mm

Packing including:

1. 1pcs LED high bay light.
2. 1pcs product user manual.
3. 1pcs installation bracket or ring.

Wiring Diagram:

AC cord

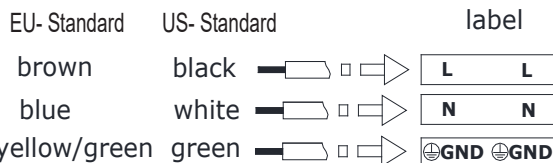

0-10V dimmable

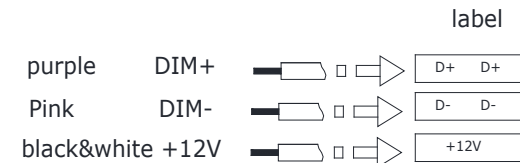

Installation instruction:

Fasten safety cable



Lamp must fasten individual safety cable

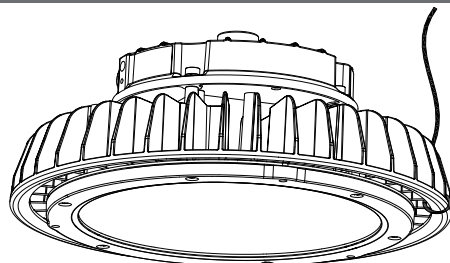

Safety rope position

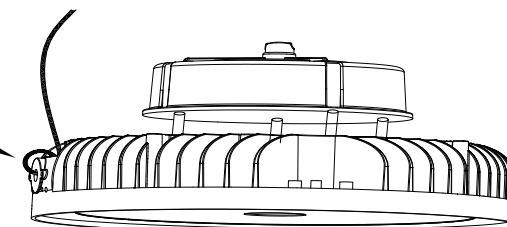

The safety rope is not included, if necessary please purchase from the seller and clarify the length.

100W/150W/200W/
240W/300W/400W

500W/600W

Hole dimension for mounting

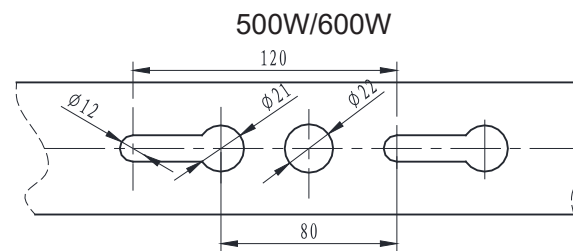
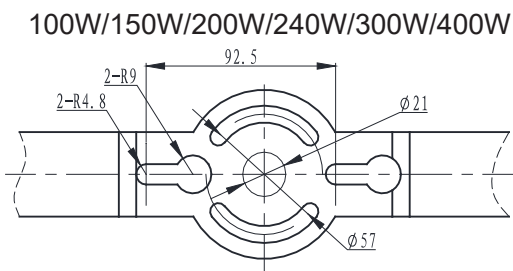

LED light dimension

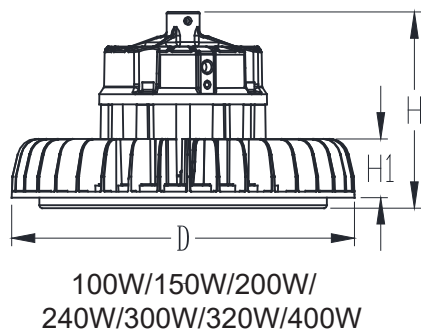

Power	Diameter D(mm)	Height H(mm)	H1(mm)
100W/150W	260	125	39
200W		145	
240W		146	
300W/400W	320	150/182	56.5

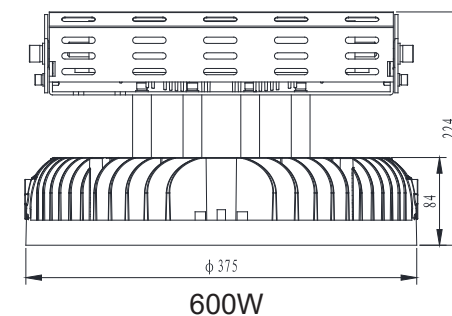
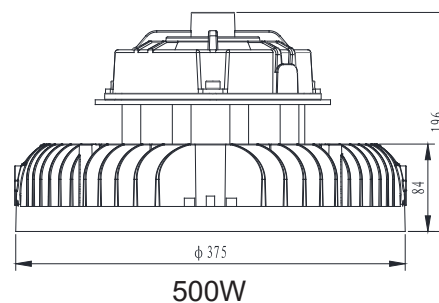

Installation

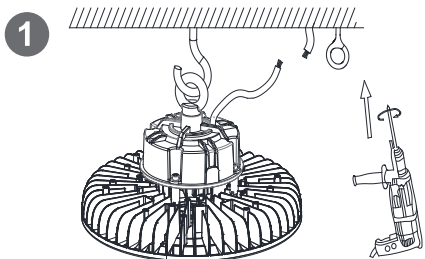

Drilling holes in the ceiling, and install the expansion screws and hook.

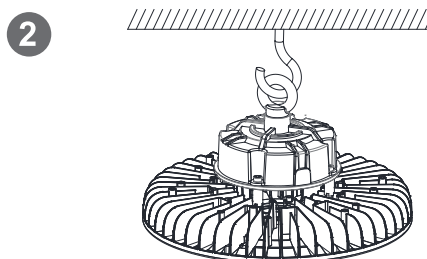

Hanging the fixture.

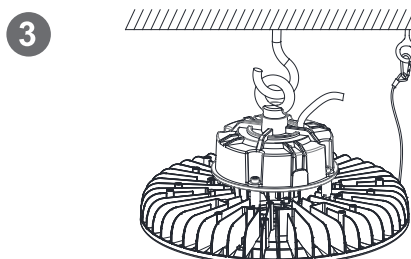

Install the safety rope and tighten the safety rope.

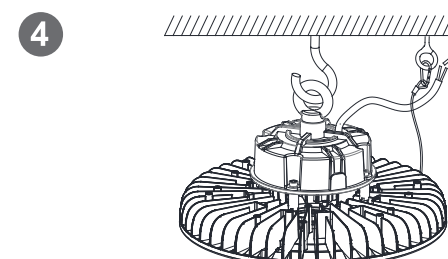

Connect the cables, Take care of the waterproof processing.

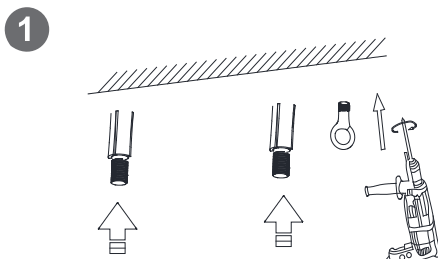

Drilling holes in the ceiling, and install the expansion screws.

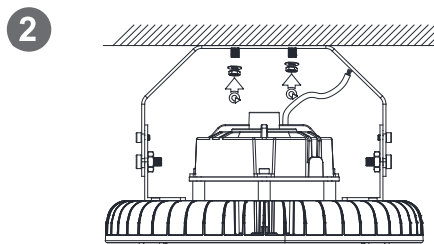

Fix the bracket.

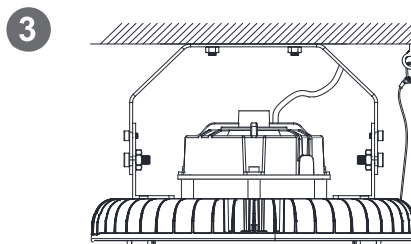

Install the safety rope and tighten the safety rope.

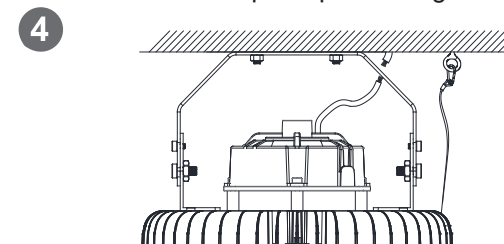

Connect the cables, Take care of the waterproof processing.