

Rings



Terminal



SR outlet

power box

Junction Box

Remote control reception

hook up



UFO lamps

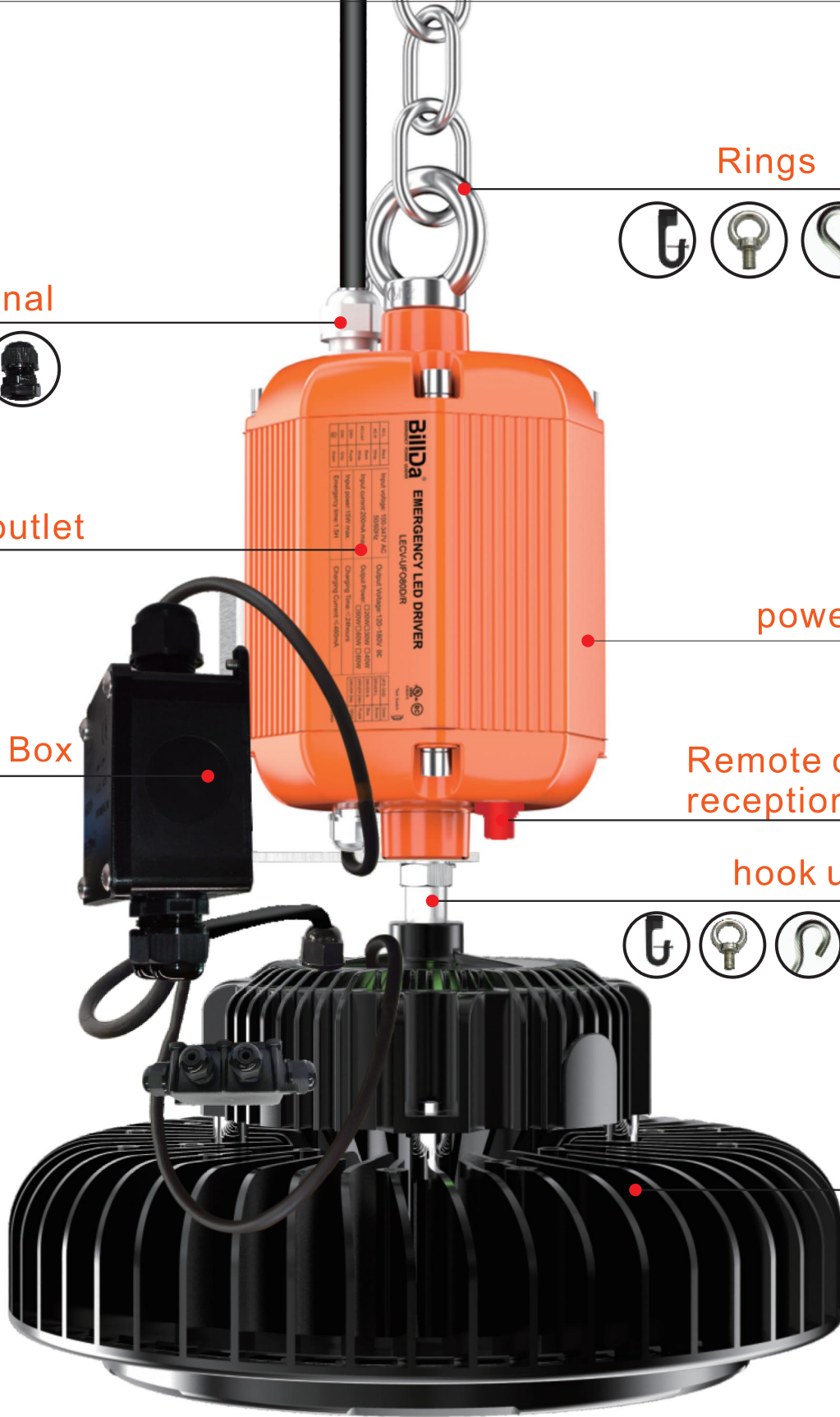

Features

Features/Benefits

1. Easy wiring: directly connect to 100-277V AC input of UFO LED High Bay.
2. Constant power output: 15W/20W
3. Universal voltage: 100-277Vac, 50/60Hz
4. IP rating: Ip65
5. Suitable for 0/1-10V dimmable UFO LED High Bay ≤300W
6. Battery protections: ,over temperature protection,over charge protection, over discharge protection,short circuit protection
7. Self testing monthly/yearly
8. Wireless remote control for emergency testing
9. CE RoHS approved
10. 3 years warranty

Specifications

Input Voltage	100-277VAC, 50/60Hz	Test Switch/Charging Indicator Light	Remote Control
Output Voltage	≤175V DC	Battery	Li-ion battery
Output Current	≤ 460mA	Charging Time	≥ 24Hours
Input Power	15W Max	Output Power	□ 15W □ 20W
Emergency Time	180 Minutes		
Warranty	3Years	Weight	3.3kg
Ambient Temp	0°C-45°C	Dimensions	142.5x108.2x108.2 mm

Model No.

Model NO	Input Voltage	Emergency power	Emergency Time
BLD-UM15D/R-YYY	100-277V/AC	15W	180Minutes
BLD-UM20D/R-YYY	100-277V/AC	20W	180Minutes

15W/20W

The Billda UFO XX D Series Led Emergency Driver s Are Designed For Use With UFO Led High Bay Fixtures With 0/1-10V Dimmable LED Drivers.it Allows The LED UFO High Bay To Be Used For Both Normal And Emergency Operation.



Colors

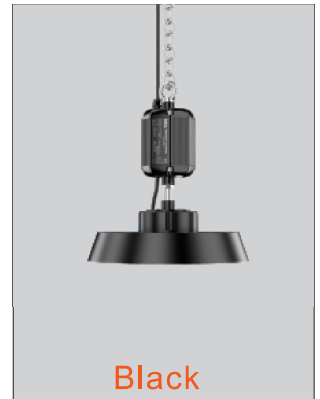
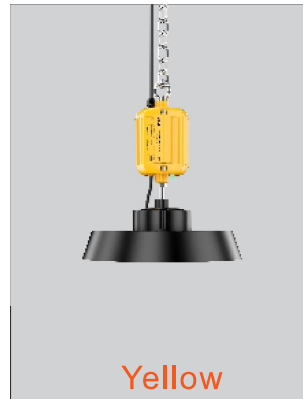

Note: Orange is default color. Black White, yellow, green and more colors are available with MOQ requirement. Please consult the factory.

Product Size

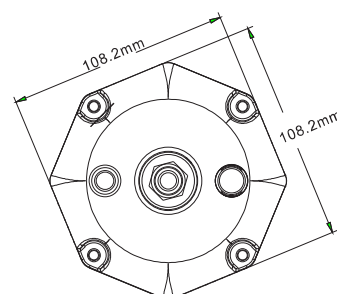
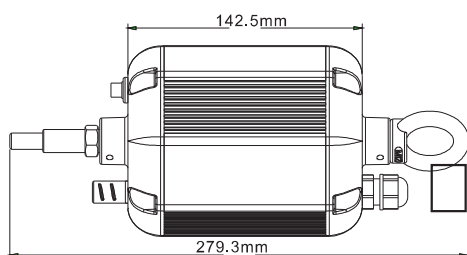

Wiring Diagram

Note: the Emergency Led Drivers Only Work With 0/1-10V Dimmable UFO LED Highbay

0-10V Dimmer Switch

1

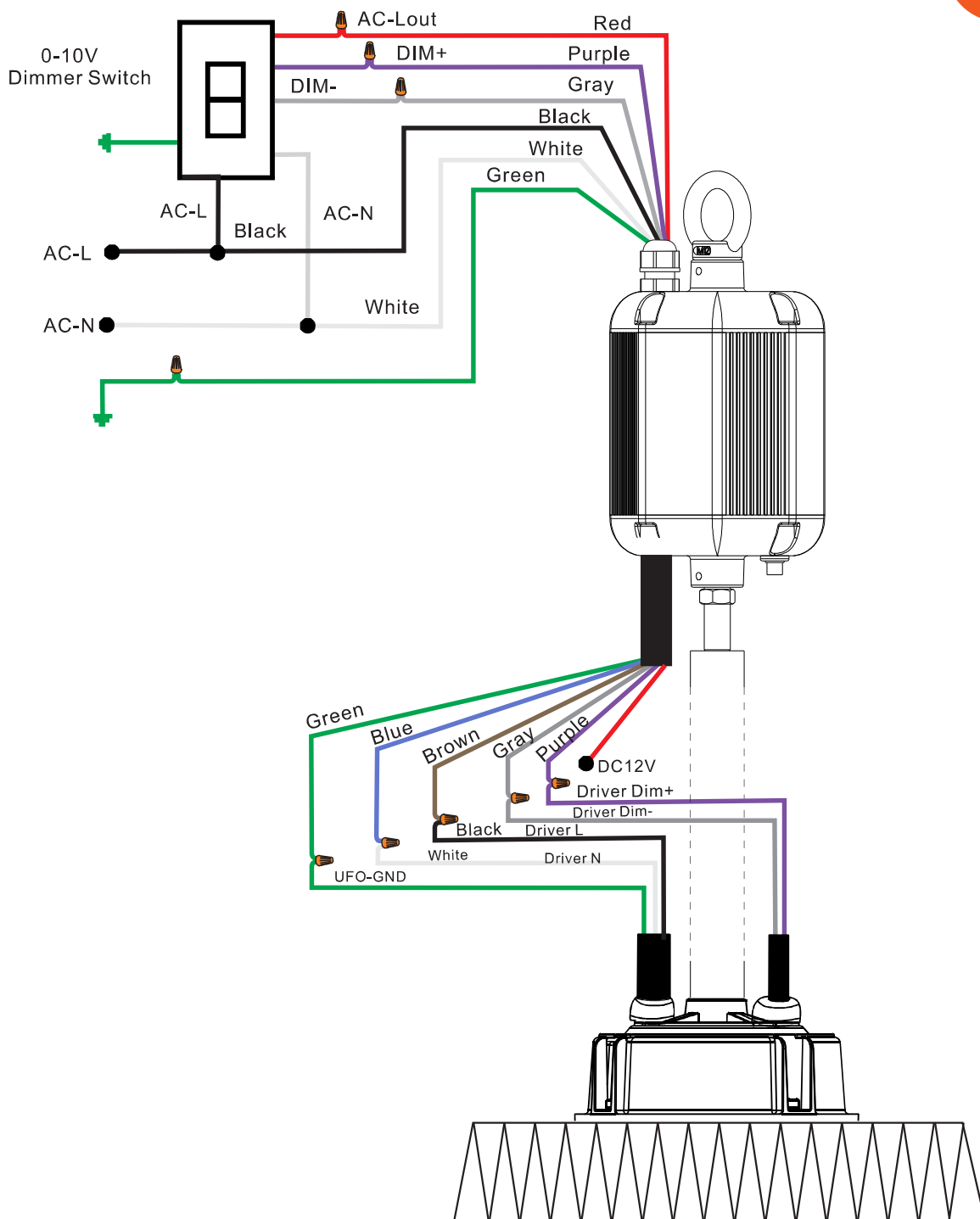

Note:the Emergency Led Drivers Only Work With 0/1-10V Dimmable UFO LED Highbay

0-10V Dimmer+Additional switch

2

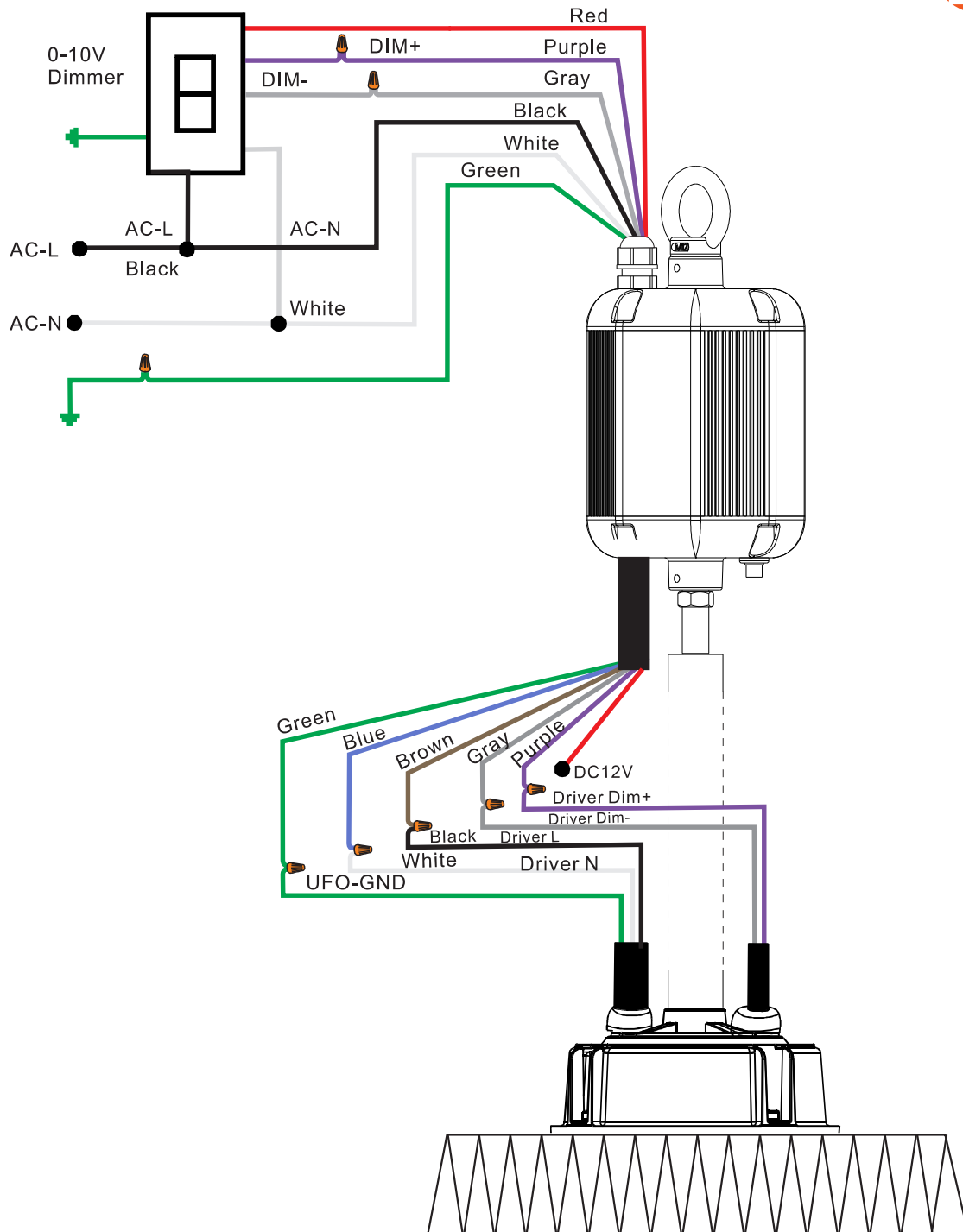

Note:the Emergency Led Drivers Only Work With 0/1-10V Dimmable UFO LED Highbay

100-277V AC Sensor

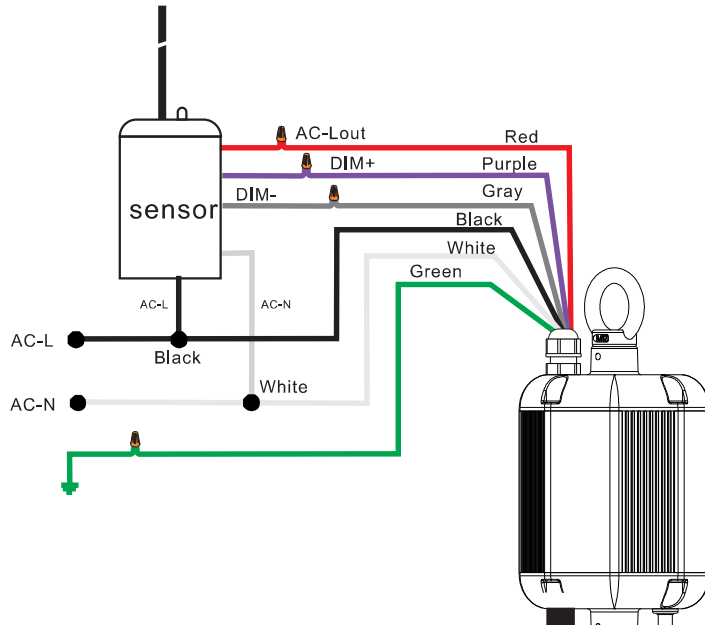

3



100-277V AC Sensor

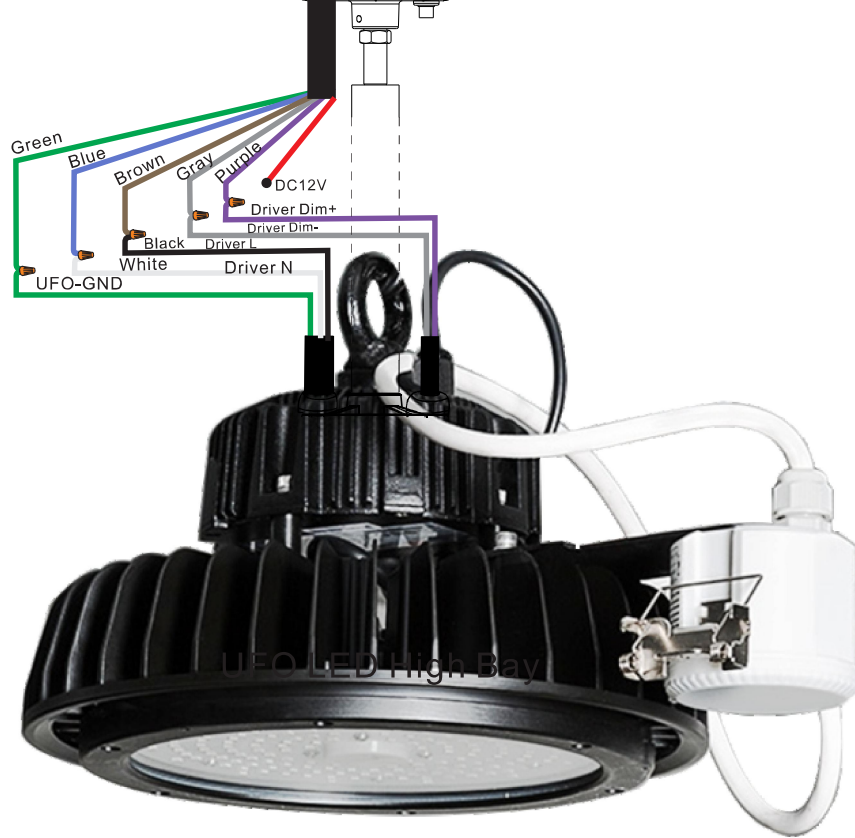

UFO LED High Bay

Note: the Emergency Led Drivers Only Work With 0/1-10V Dimmable UFO LED Highbay

DC12V Sensor+with/without 0-10V Dimmer switch

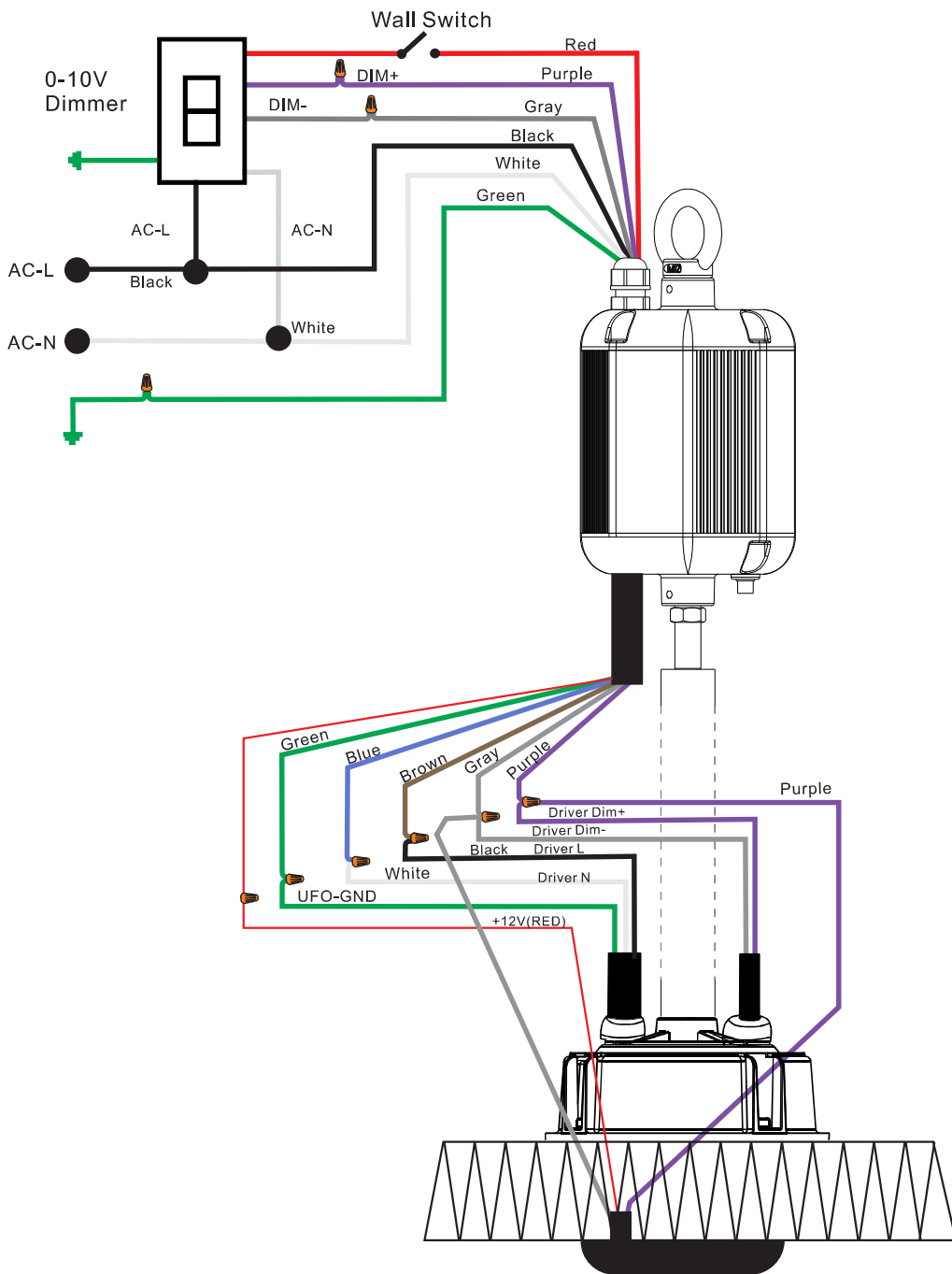

4



DC12V Sensor

Note:the Emergency Led Drivers Only Work With 0/1-10V Dimmable UFO LED Highbay

With Wall Switch(without Dimmer)

5

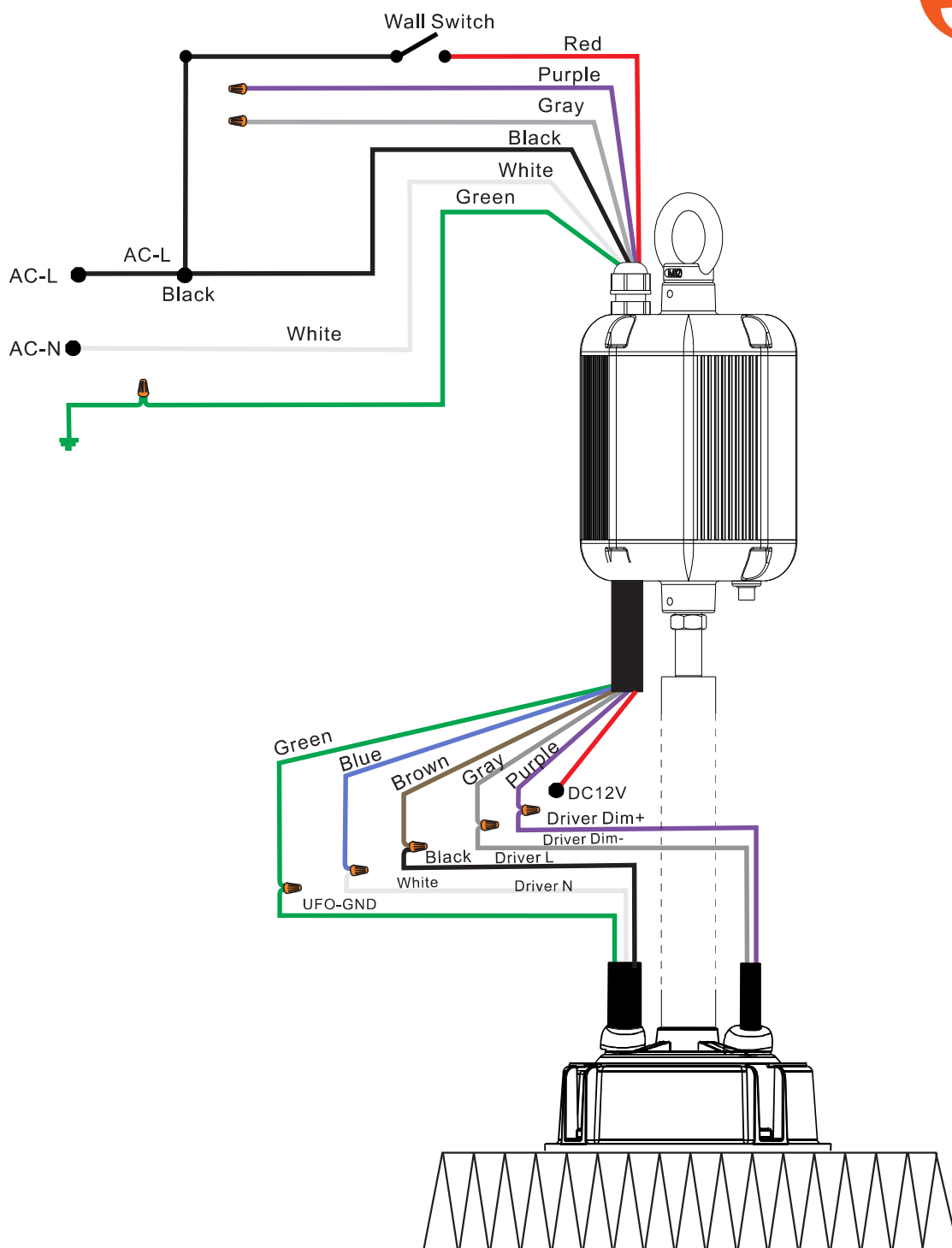

Note: the Emergency Led Drivers Only Work With 0/1-10V Dimmable UFO LED Highbay

Without Dimmer & Switch, 24hours Lighting

6

