

Product Information

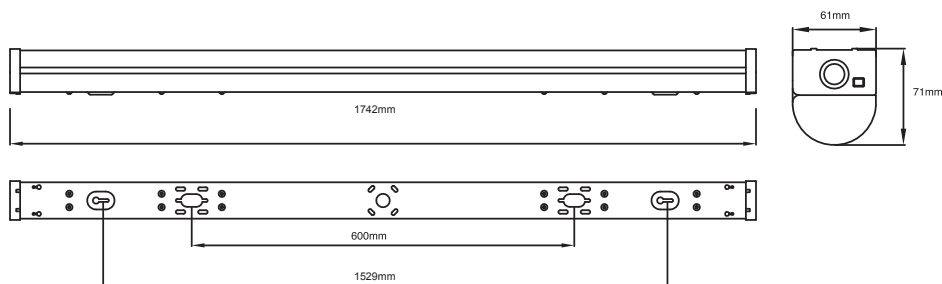

Technical Specifications

Model	Voltage	Power	Lumen (±5%)	Lumen per Watt	Energy Efficiency Class	Power Factor	Beam angle	CCT	Lifespan	CRI	Dimmable	Dimension
S30134	AC 220-240V	35/42/50/62W	5250/6300/7500/9300	150lm/W	C	>0.9	120°	3000K/4000K/6500K	50000h	>80	No	1742*61*71mm, fixing distance 1529mm

Driver data Sheet

Driver data	DIM
Input rated Voltage	AC220-240V
Frequency	50/60Hz
Input Voltage	200-240VAC
Efficiency	91.5%
Total load Wattage	MAX. 60.2W
Power Factor	>0.95
Rated input current	<0.34A
Full load output Voltage	100 - 172/200VDC
Rated output current	200/250/300/350mA
Output current range	200/250/300/350±15mA
Power tolerance	±5%
Current output tolerance	±15mA
Withstand voltage	1750V
Short circuit protection	PASS
Overload protection	PASS
No-load protection	PASS

Fixture Compatibility

Rated Wattage	Electrical Classification	Ingress Protection	Operating Temp	Operating Humidity	Storage Temp
Max.62W	I	IP20	-20°C-45°C	10-90%	-40°C-80°C

Spectral Distribution

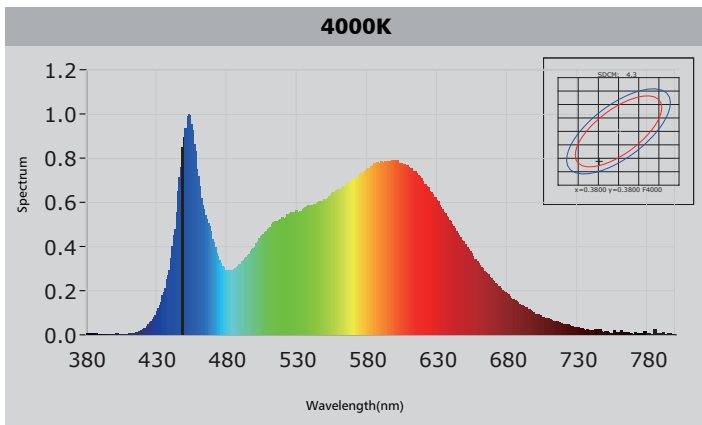
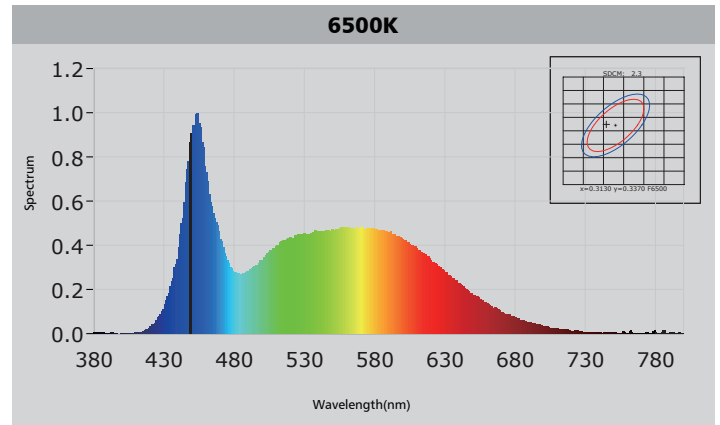
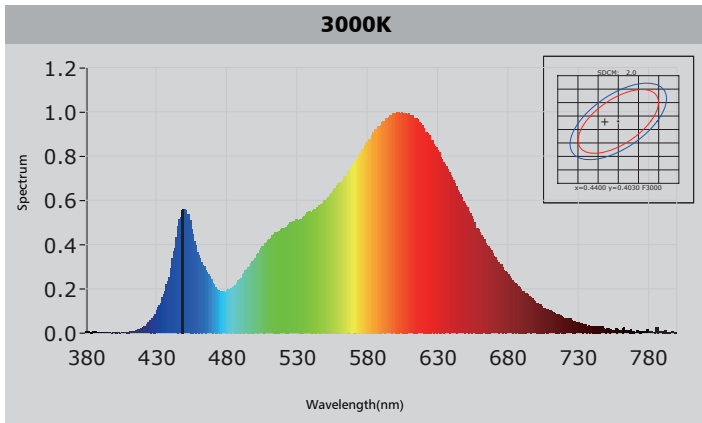

Photometric Diagram

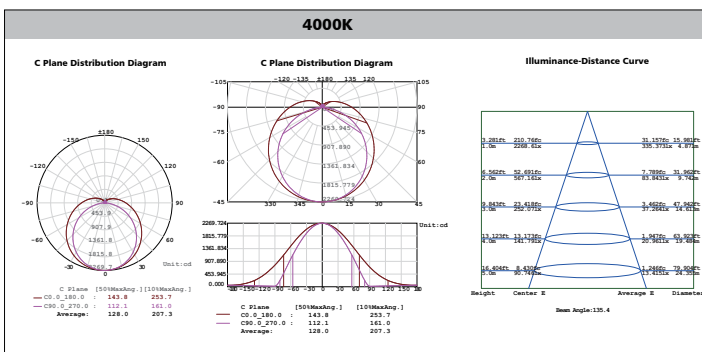
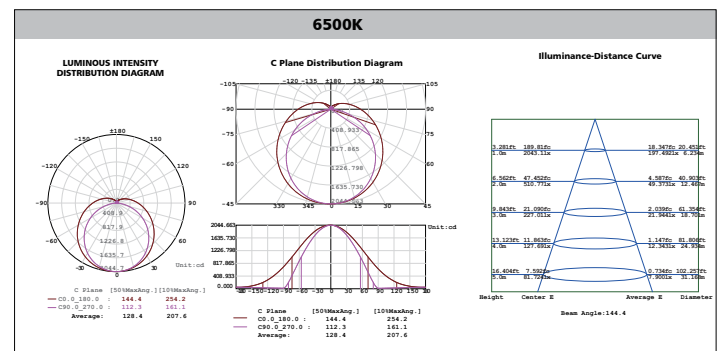
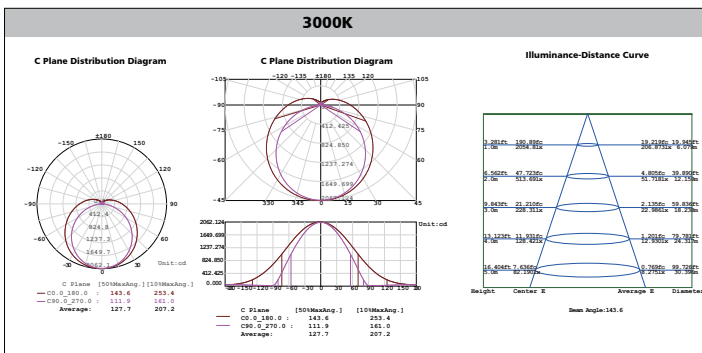

Polar Diagram Comparison

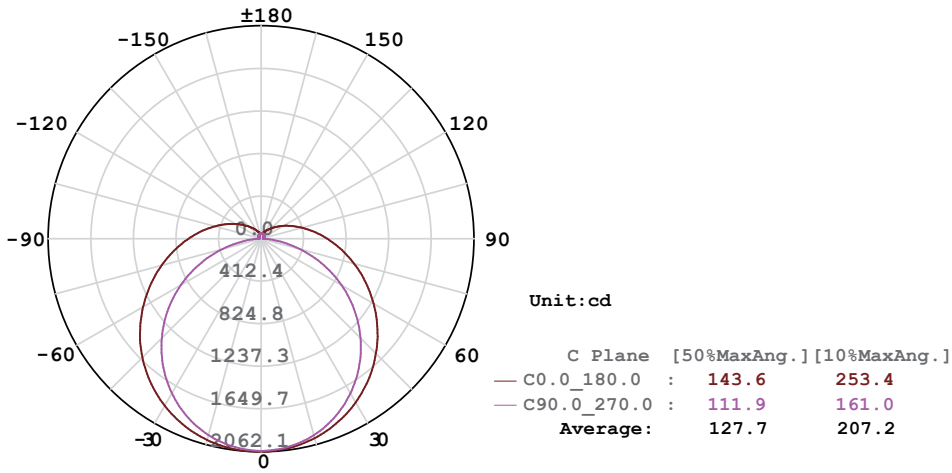

Average Lumen Maintenance and Chromaticity Shift VS. Time

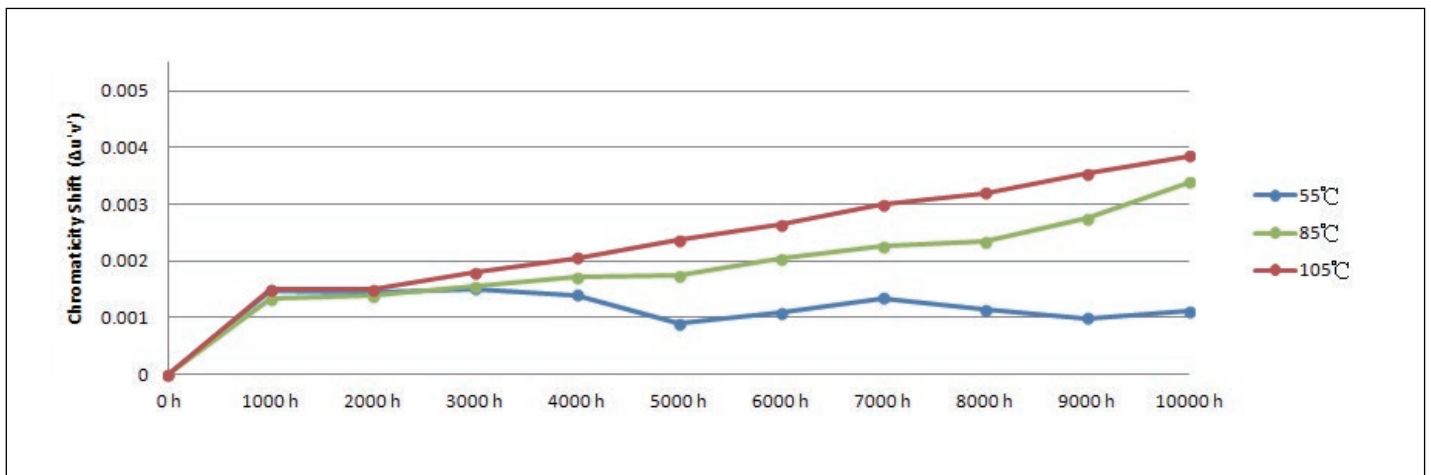

Installation

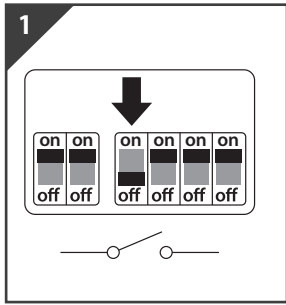

Switch OFF at mains supply before installing

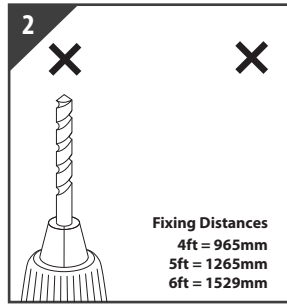

Drill holes to the required distance and install plugs

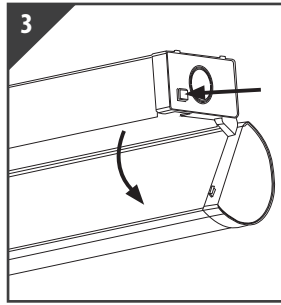

Push button on end-cap and pull open casing

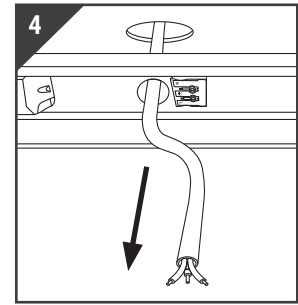

Pull cable from ceiling through hole in batten

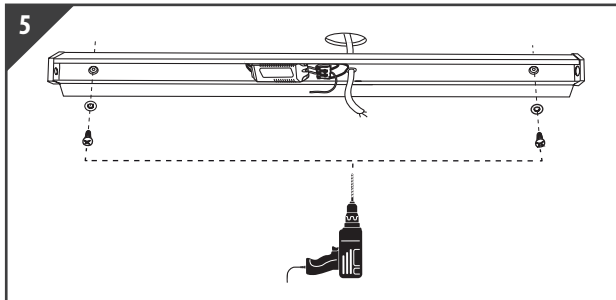

Drill screws into previously installed plugs

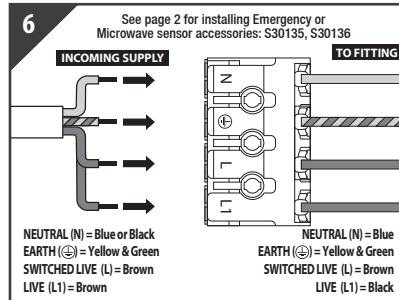

Push down the terminal, insert correct supply (as above) into terminal block, for the emergency unit to work correctly please ensure that an uninterrupted permanent live feed is present and is connected directly to the (L1) "Permanent Live" terminal of the connector block. Release the push fit terminal to secure.

Note: Please ensure there are no switches, PIRS etc in the permanent live feed, as switching of the emergency pack will reduce the battery's life considerably.

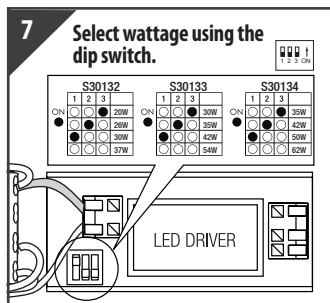

Select wattage using the dip switch.

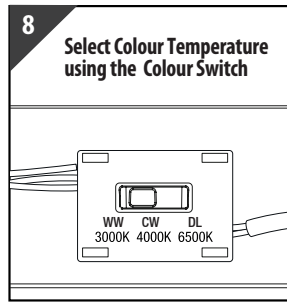

Select Colour Temperature using the Colour Switch

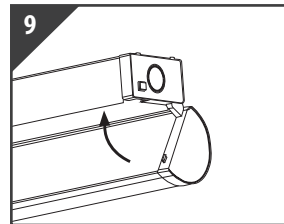

Close casing ensuring it clicks into place

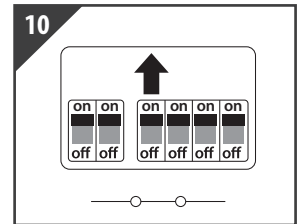

Return power. Switch ON at mains supply

Packaging Information

	SIZE(CM)	N.W/pc (KGS)	G.W.(KGS)	Q'TY(PCS)
Carton	175.5*21.5*16.5	1.9	14.5	6

	CTNS	Q'TY(PCS)	VOLUME(CBM)
20" standard container	451	2706	27.96
40" standard container	935	5610	57.96

