

Product Information

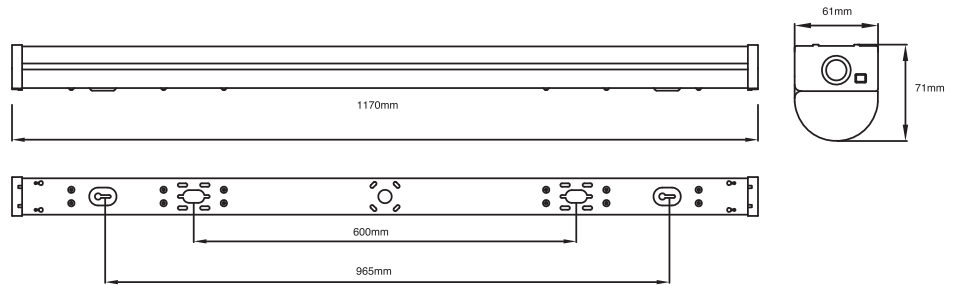

Technical Specifications

Model	Voltage	Power	Power Factor	Lumen (±5%)	Beam angle	CCT	Lifespan	CRI	Dimmable	Dimension
S15402	AC 220-240V	20W	>0.9	2600	120°	4000K	50000h	>80	No	1170*61*71mm, fixing distance 965mm

Driver data Sheet

Driver data	DIM
Input rated Voltage	AC220-240V
Frequency	50/60Hz
Input Voltage	AC180-264V
Efficiency	≥85%
Total load Wattage	21W
Power Factor	≥0.95
Rated input current	<0.2A
Full load output Voltage	28-42V
Rated output current	500mA
Output current range	500±25mA
Power tolerance	±5%
Current output tolerance	±25mA
Withstand voltage	2000V
Short circuit protection	PASS
Overload protection	PASS
No-load protection	PASS

Fixture Compatibility

Rated Wattage	Electrical Classification	Ingress Protection	Operating Temp	Operating Humidity	Storage Temp
20W	I	IP20	-20°C-45°C	10-90%	-40°C-80°C

Spectral Distribution

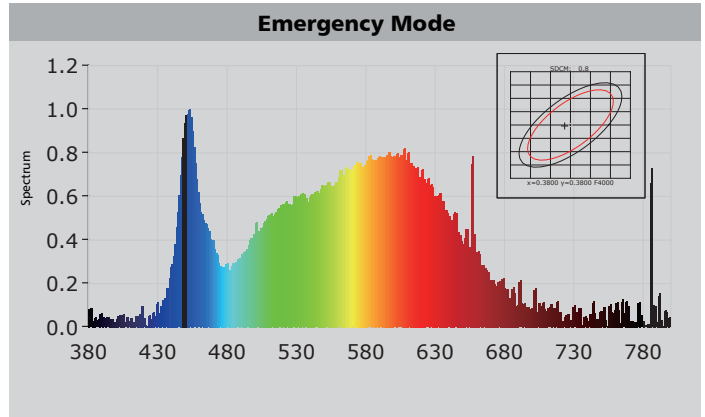
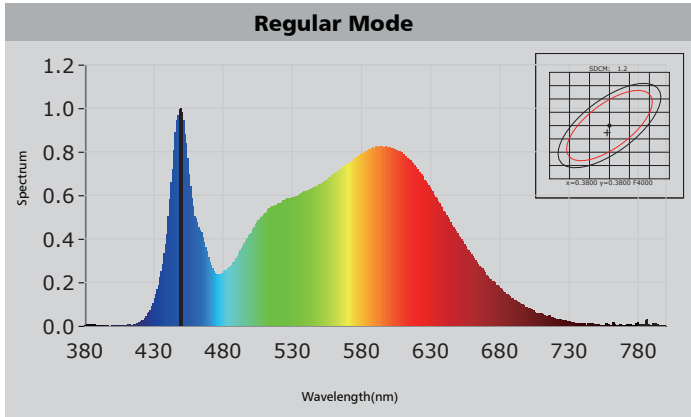

Photometric Diagram

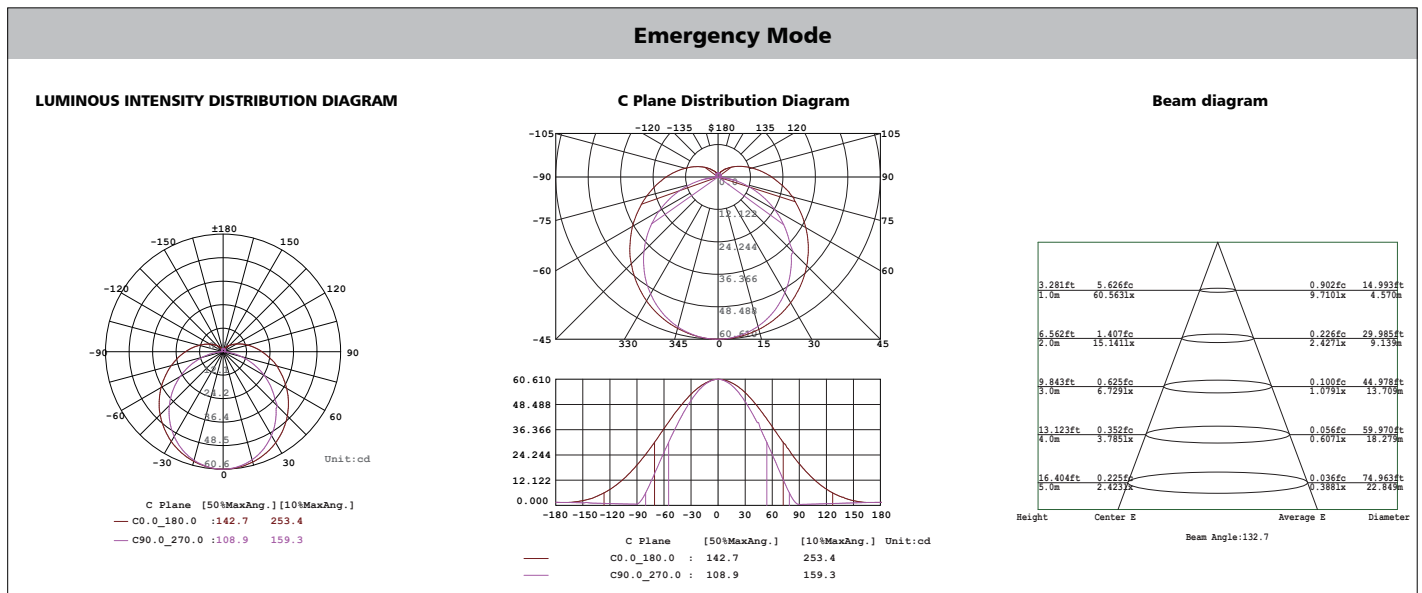
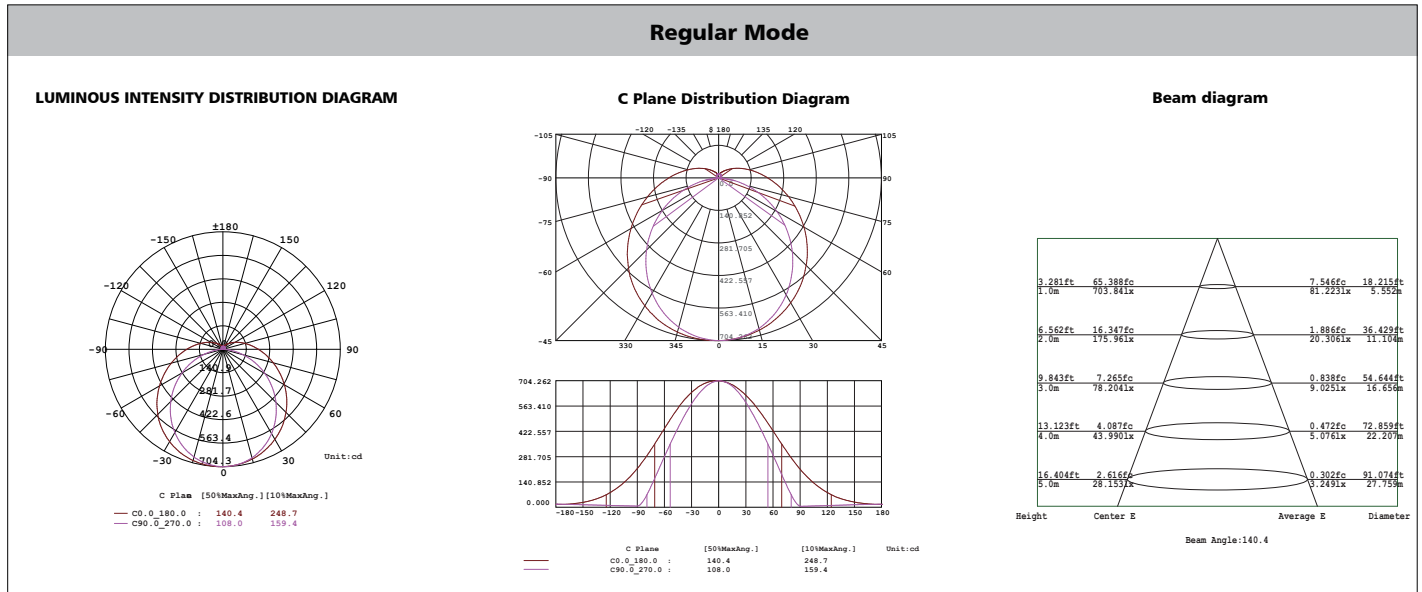

Polar Diagram Comparison

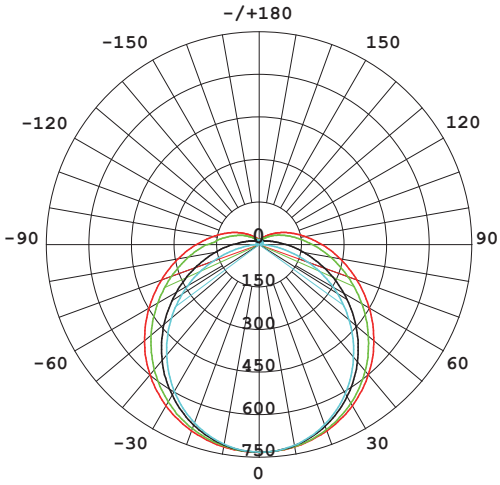

AVERAGE BEAM ANGLE (50%) : 123.7 DEG

Average Lumen Maintenance and Chromaticity Shift VS. Time

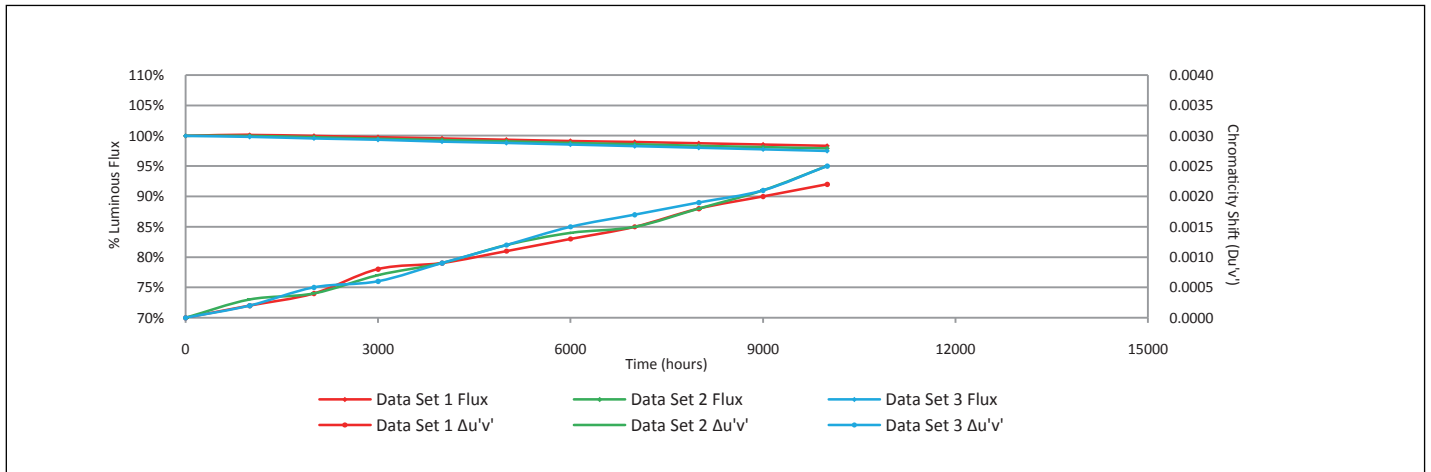

Installation

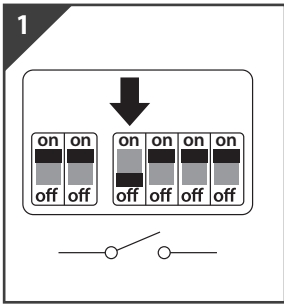

Switch OFF at mains supply before installing

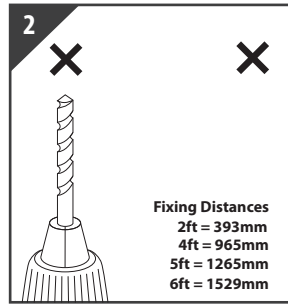

Drill holes to the required distance and install plugs

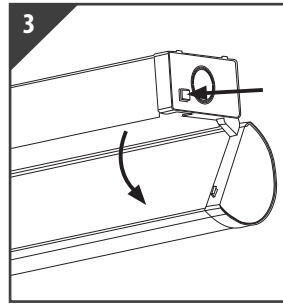

Push button on end-cap and pull open casing

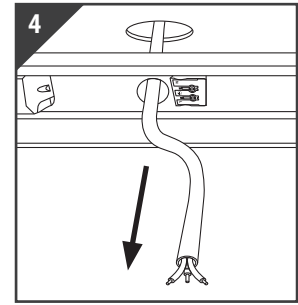

Pull cable from ceiling through hole in batten

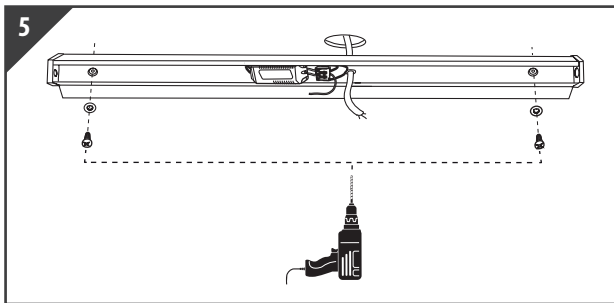

Drill screws into previously installed plugs

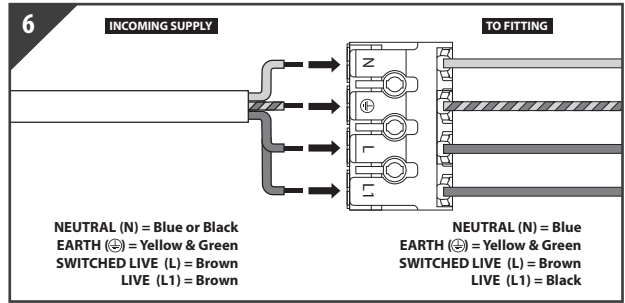

Push down the terminal, insert correct supply (as above) into terminal block, for the emergency unit to work correctly please ensure that an uninterrupted permanent live feed is present and is connected directly to the (L1) "Permanent Live" terminal of the connector block. Release the push fit terminal to secure.

Note: Please ensure there are no switches, PIRS etc in the permanent live feed, as switching of the emergency pack will reduce the battery's life considerably.

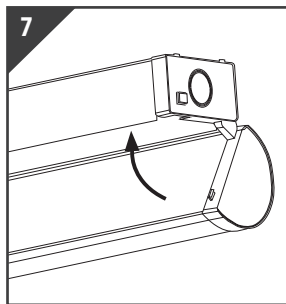

Close casing ensuring it clicks into place

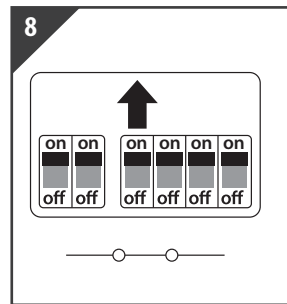

Return power. Switch ON at mains supply

Packaging Information

	SIZE(CM)	N.W/pc (KGS)	G.W.(KGS)	Q'TY(PCS)
Carton	119*36.5*17.5	1.4	15	10

	CTNS	Q'TY(PCS)	VOLUME(CBM)
20" standard container	365	3650	27.74
40" standard container	760	7600	57.75

