

Product Information

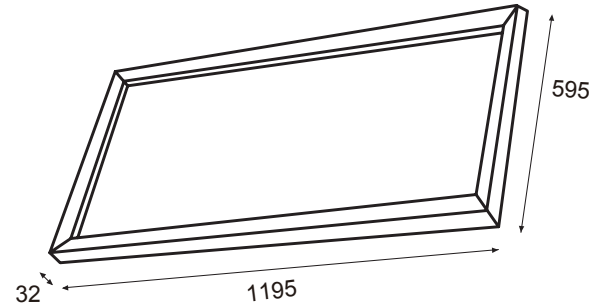

Technical Specifications

Model	Size	Voltage	Power	LMW	Lumen (±5%)	Kelvin	LED Lens	Front Diff	Warranty	Hours	Type	Flicker free	Driver Brand	LED Brand	UGR	TPa/TPb	IP	Height	Power Factor	Beam angle	CRI
S16287	60120	AC 220-240V	60W	100	6000	CCT(4000K/5000K/6000K)	PMMA	PS	5	50,000.00	Backlit	Yes	Lifud	Sanan	<19	TPa	IP20	32mm	0.9	90°	>80

Driver data Sheet

Driver data	DIM
Input rated Voltage	AC220-240V
Frequency	47Hz-63Hz
Input Voltage	AC198-264V
Efficiency	≥87.5%
Total load Wattage	60W
Power Factor	≥0.95
Rated input current	0.5A Max
Full load output Voltage	33-40Vdc
Rated output current	1500mA
Output current range	1500mA±5%
Power tolerance	±5%
Current output tolerance	±5%
Withstand voltage	3750V
Short circuit protection	PASS
Overload protection	PASS
No-load protection	PASS

Fixture Compatibility

Rated Wattage	Electrical Classification	Ingress Protection	Operating Temp	Operating Humidity	Storage Temp
60W	II	IP20	-20 C ~ +45 C	20-90%RH	-20 C ~ + 80 C

Spectral Distribution

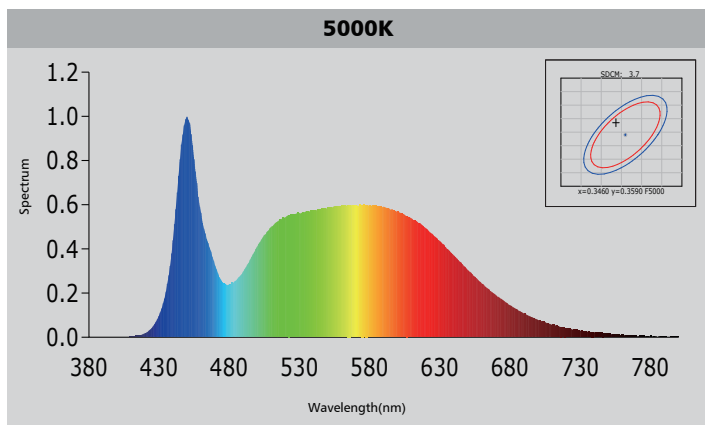
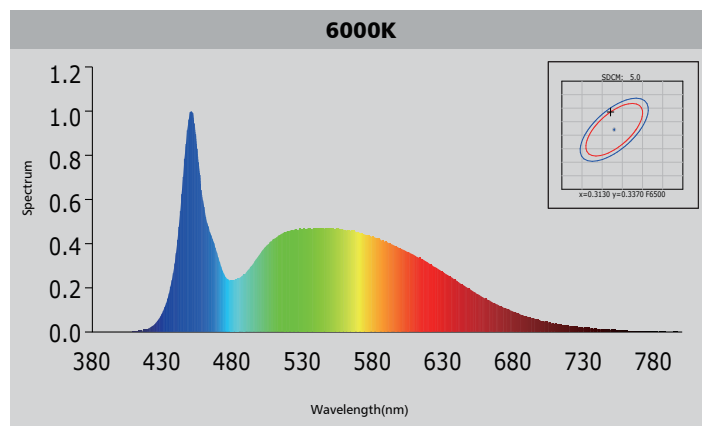
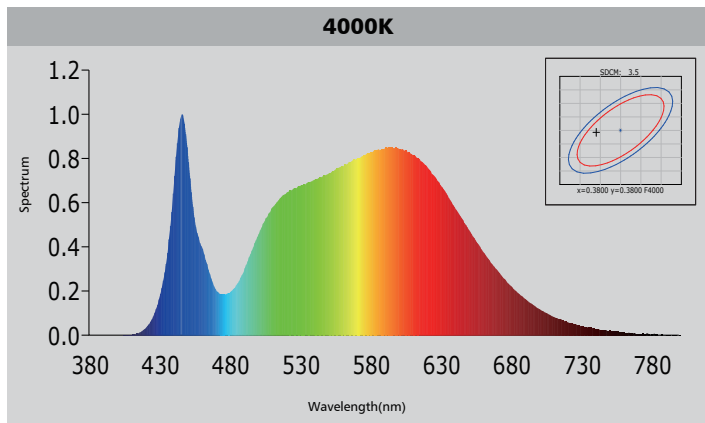

Photometric Diagram

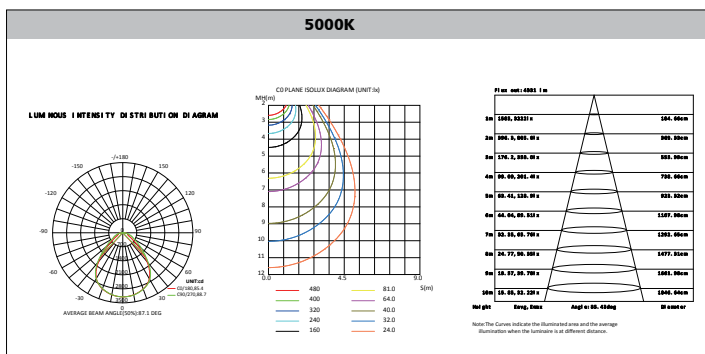
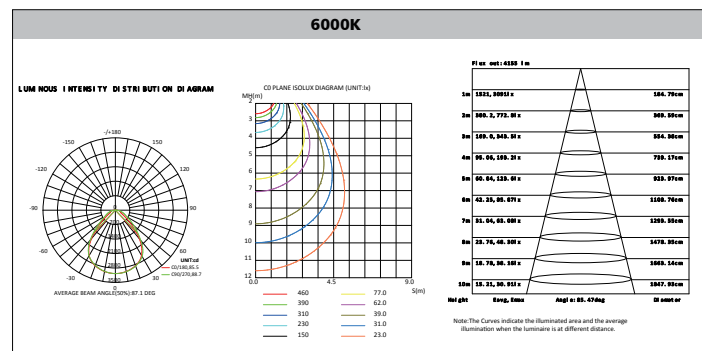
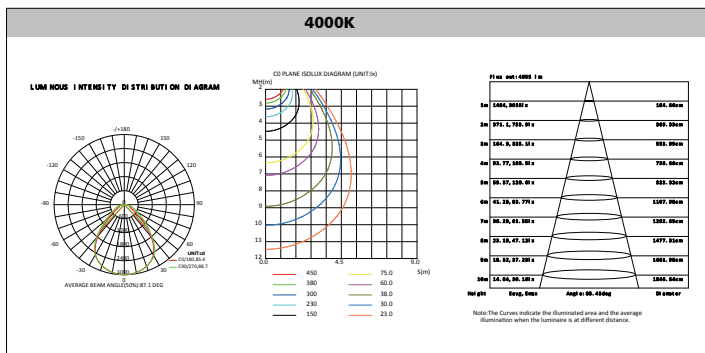

Luminous Intensity Distribution Diagram

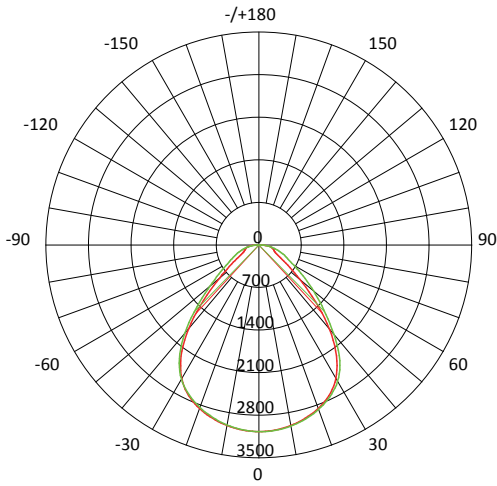

UNIT : cd
 — C0/180 , 85.5
 — C90/270 , 88.7



AVERAGE BEAM ANGLE (50%) : 87.1 DEG

Average Lumen Maintenance and Chromaticity Shift VS. Time

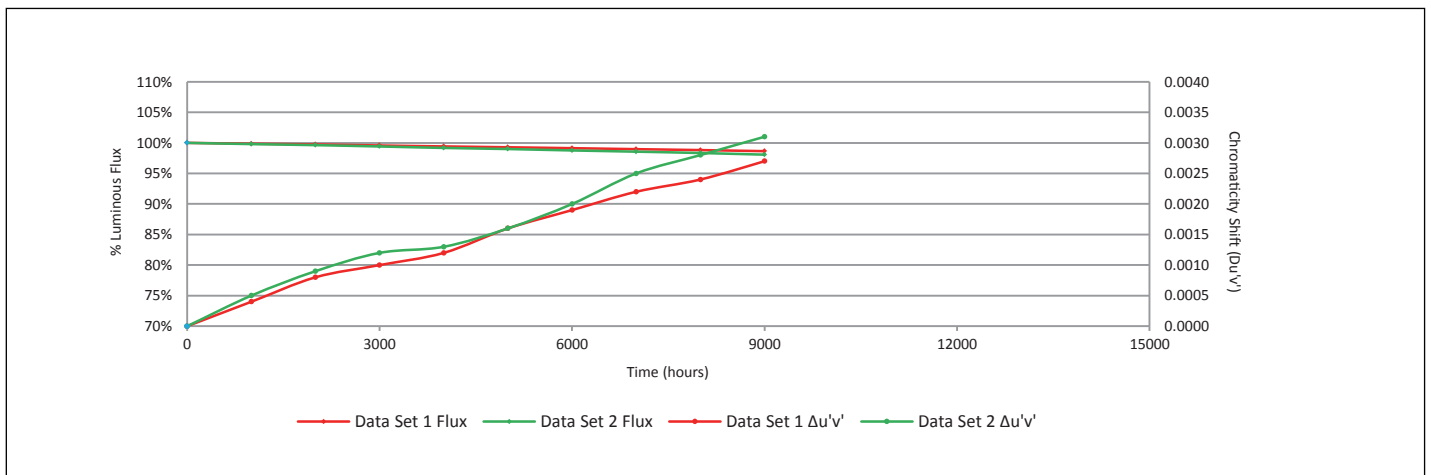

Installation

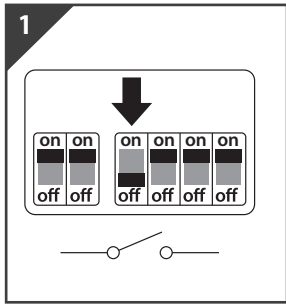

Switch OFF at mains supply before installing

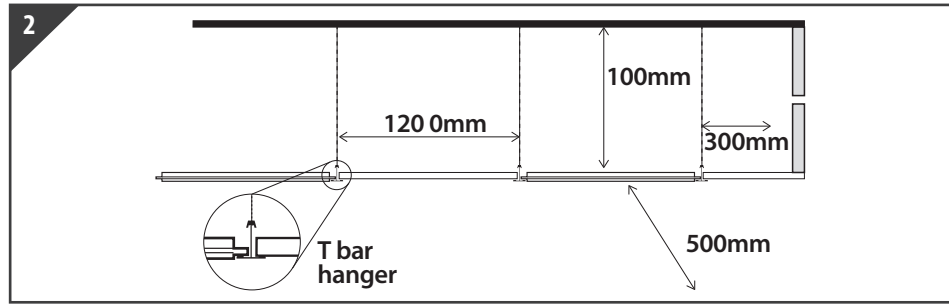

Ensure that there is adequate space for panel installation in suspended ceiling

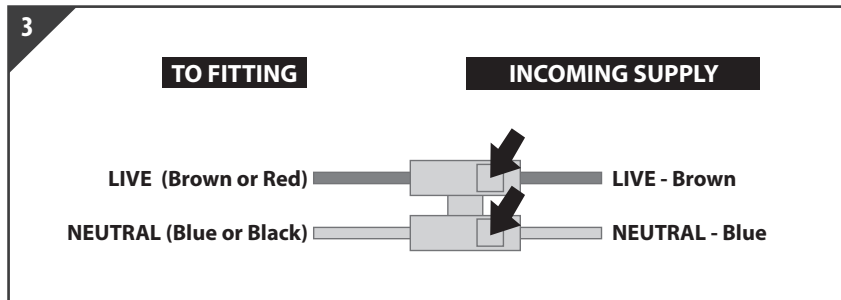

Insert correct supply and wiring from the driver into terminal block (not provided), tighten all screws in block

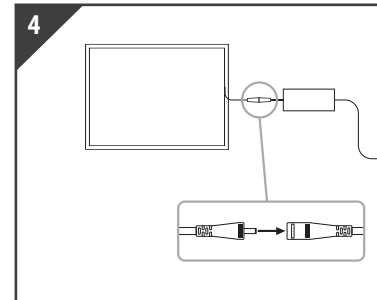

Connect driver to panel

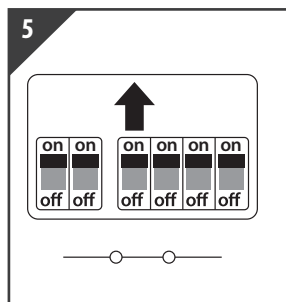

Return power. Switch ON at mains supply

Packaging Information

	SIZE(CM)	N.W/pc (KGS)	G.W.(KGS)	Q'TY(PCS)
Carton	126.5*16.5*62.5	3.85	18	4

	CTNS	Q'TY(PCS)	VOLUME(CBM)
20" standard container	220	880	27
40" standard container	457	1828	56

